

MAX

RB655

**RE • BAR-TIER
RE • BAR TYING TOOL**

**LIEUSE DE BARRES
D'ARMATURE
OUTIL POUR LIER LES BARRES
D'ARMATURE**

**MÁQUINA DE BATERIA
ATADORA PARA LA FERRALLA
HERRAMIENTA LIGADORA DE
BARRAS DE REFUERZO**



OPERATING and MAINTENANCE MANUAL MANUEL D'OPERATION ET D'ENTRETIEN MANUAL DE OPERACIÓN Y MANTENIMIENTO

▲ WARNING:

BEFORE USING THIS TOOL, STUDY THIS MANUAL TO ENSURE SAFETY WARNING AND INSTRUCTIONS.
KEEP THESE INSTRUCTIONS WITH THE TOOL FOR FUTURE REFERENCE.

▲ AVERTISSEMENT:

AVANT D'UTILISER CET OUTIL, NOUS VOUS RECOMMANDONS DE BIEN ÉTUDIER CE MANUEL POUR S'ASSURER QUE LES AVERTISSEMENTS DE SÉCURITÉ ET LES INSTRUCTIONS SONT BIEN OBSERVÉES.
CONSERVER CES INSTRUCTIONS AVEC L'OUTIL POUR UNE FUTURE RÉFÉRENCE.

▲ ADVERTENCIA!

ANTES DE USAR ESTA HERRAMIENTA, SE RECOMIENDA LEER CUIDADOSAMENTE ESTE MANUAL PARA ASEGURARSE QUE SE HAYAN TOMADO EN CONSIDERACIÓN LAS ADVERTENCIAS DE SEGURIDAD E INSTRUCCIONES.
CONSERVAR ESTAS INSTRUCCIONES CON LA HERRAMIENTA PARA REFERENCIA FUTURA.

INDEX

INDEX

INDICE

ENGLISH **Page 3 to 22 Page**

FRANÇAIS **Page 23 to 42 Page**

ESPAÑOL **Page 43 to 62 Page**

DEFINITIONS OF SIGNAL WORDS

- WARNING:** Indicates a potentially hazardous situation which, if not avoided, could result in death or serious injury.
- CAUTION:** Indicates a potentially hazardous situation which, if not avoided, may result in minor or moderate injury.
- NOTE:** Emphasizes essential information.

DEFINITIONS DES INDICATEURS PRINCIPAUX

- AVERTISSEMENT:** Indique une situation potentiellement à risque qui, si elle n'est pas évitée, peut résulter en un danger mortel ou une blessure grave.
- PRECAUTION:** Indique une situation potentiellement à risque qui, si elle n'est pas évitée, peut résulter en une blessure mineure ou modérée.
- NOTE:** Accentue les informations essentielles.

DEFINICIONES DE LOS INDICADORES PRINCIPALES

- ¡ADVERTENCIA!** Indica una situación potencialmente peligrosa que, si no se evita, puede resultar en muerte o lesiones graves.
- PRECAUCIÓN:** Indica una situación potencialmente peligrosa, que si no se evita, puede resultar en una herida menor o moderada.
- NOTA:** Destaca las informaciones esenciales.

ENGLISH

RB655

RE • BAR-TIER

INDEX

1. SPECIFICATIONS & TECHNICAL DATA	4
2. SAFETY INSTRUCTIONS	6
3. SAFETY FEATURES	10
4. BATTERY INSTRUCTIONS	11
5. OPERATING INSTRUCTIONS.....	14
6. TROUBLESHOOTING/REPAIRS.....	20
7. MAINTENANCE	22
8. STORAGE	22

OPERATING and MAINTENANCE MANUAL

WARNING:

BEFORE USING THIS TOOL, STUDY THIS MANUAL TO ENSURE SAFETY WARNING AND INSTRUCTIONS.

KEEP THESE INSTRUCTIONS WITH THE TOOL FOR FUTURE REFERENCE.

1. SPECIFICATIONS AND TECHNICAL DATA

1. NAME OF PARTS

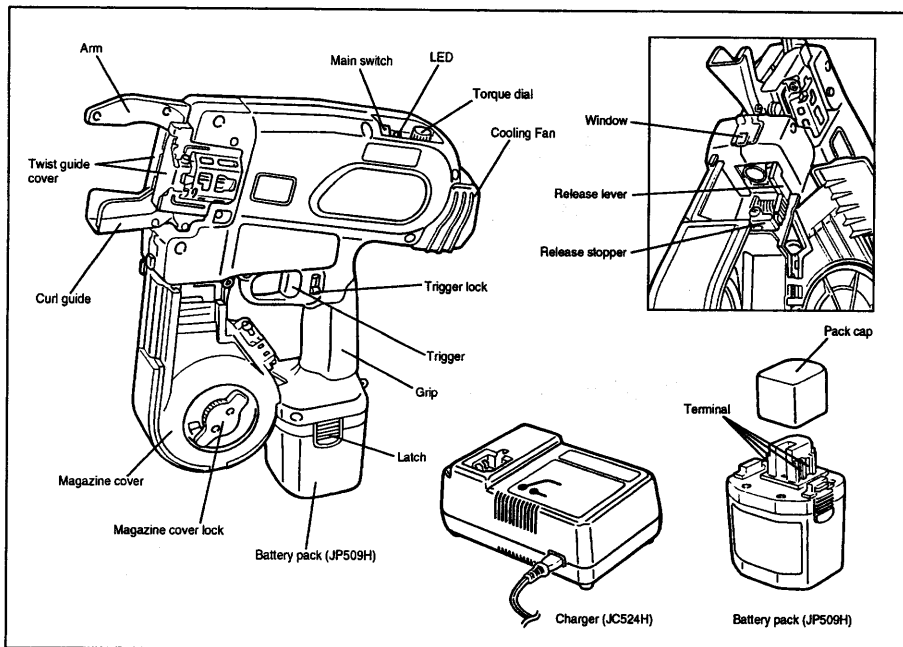

2. TOOL SPECIFICATIONS

PRODUCT NO.	RB655
WEIGHT	7.2 lbs (3.3 kg)
HEIGHT	13-3/8" (340 mm)
WIDTH	4" (100 mm)
LENGTH	13-3/8" (340 mm)
WRAPS PER TIE	1 wrap / tie
BATTERY	Ni-MH 9.6V (JP509H)
CHARGING TIME	Approx. 30 minutes
ACCESSORIES	Battery pack JP509H Battery Charger JC524H, Holster Carrying case

3. WIRE SPECIFICATIONS

NAME	MAX TIE-WIRE		
MODEL	TW1525	TW1525EG	TW1525PC
DIAMETER	16 GA. ϕ 1.5 mm	16 GA. ϕ 1.5 mm	16 GA. ϕ 1.7 mm
LENGTH	82 feet/coil (25 m/coil)	82 feet/coil (25 m/coil)	82 feet/coil (25 m/coil)
FINISH	Bright	Galvanized	Plastic coated
TIES PER COIL	110~210 ties/coil	110~210 ties/coil	110~180 ties/coil
TIES PER CHARGE	Approx. 420 ties/charge	Approx. 420 ties/charge	Approx. 420 ties/charge

BATTERY CHARGER:

Use only an authorized Battery charger, MAX Battery Charger JC524H.

4. TECHNICAL DATA

① NOISE

A-weighted single-event ----- LWA, 1s, d 89.3 dB

sound power level

A-weighted single event ----- LpA, 1s, d 79.1 dB

emission sound pressure

level at work station

These values are determined and documented in accordance to EN12549 : 1999.

② VIBRATION

Vibration characteristic value = 0.53 m/s²

These values are determined and documented in accordance to ISO 8662-11.

This value is a tool-related characteristic value and does not represent the influence to the hand-arm-system when using the tool. An influence to the hand-arm-system when using the tool will, for example, depend on the gripping force, the contact pressure force, the working direction, the adjustment of main supply, the workpiece, the workpiece support.

③ RADIATED EMISSION 30-1000 MHZ

Class B

5. APPLICATIONS

- * Construction works (bridge, road, etc.)
Commercial building
- * Making pre-cast concrete products.
- * Building floor and wall.

6. RECOMMENDED REINFORCING BAR COMBINATION CHART

The minimum bar size combination

#3 × #3 (φ 10 mm × φ 10 mm)

The maximum bar size combination

#9 × #8 (φ 29 mm × φ 25 mm)

7. CONSUMABLE PARTS

The parts shown below are consider normal wearing parts.

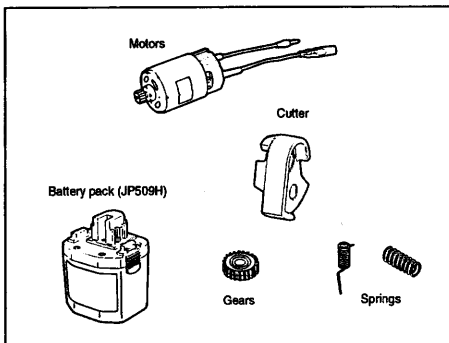

2. SAFETY INSTRUCTIONS

▲ WARNING:

TO AVOID SEVERE PERSONAL INJURY OR PROPERTY DAMAGE BEFORE USING THE TOOL, READ CAREFULLY AND UNDERSTAND THE FOLLOWING "SAFETY INSTRUCTIONS":

PRECAUTIONS ON USING THE TOOL

This equipment is a tool for use in tying re-bars. Using this equipment for other applications or in ways not specified in the manual may lead to serious accident. Be sure to strictly observe the items written in this manual. Persons not concerned with the work, particularly children, should be kept away from the work site and should not be allowed to touch this equipment.



1. WEAR SAFETY GLASSES OR GOGGLES

The employer and the user must make sure that proper eye protection is worn when the tool is being used. Eye protection equipment must conform to the requirements of the American National Standards Institute, ANSI Z87.1 (Council Directive 89/686/EEC of 21 DEC. 1989) and it must provide frontal and side protection.

NOTE: Nonside-shielded spectacles and face shields alone do not provide adequate protection.



2. EAR PROTECTION MAY BE REQUIRED IN SOME ENVIRONMENTS

Because working conditions may include exposure to high noise levels that could lead to hearing damage, the employer and the user should make sure that necessary hearing protection is provided and used by the operator and others in the work area.

3. DON'T ALLOW CHILDREN NEAR THE TOOL

Allow no bystanders, especially children, near the tool during its operation.



4. DON'T USE THE TOOL IN THE RAIN, WHERE WATER IS SPLASHING, IN A WET PLACE, OR IN A DAMP PLACE

Using the tool in these or similar conditions will increase the risk of electric shock.



5. INSPECT THE PARTS BEFORE MOUNTING THE BATTERY PACK

- Examine the screws to make sure they are securely tightened.

Incomplete tightening may result in an accident or breakage. If a screw is loose, retighten it completely.

- Inspect parts for damage.

Parts will wear over periods of use. Look also for missing and defective parts and for parts of poor quality. If a part must be replaced or repaired, purchase the replacement part at an authorized MAX Co., Ltd. distributor.

Use only genuine authorized replacement parts.



6. BE SURE TO SET THE MAIN SWITCH TO OFF, TO LOCK THE TRIGGER, AND DETACH THE BATTERY PACK WHEN CHANGING THE BATTERY PACK, WHEN REPLACING OR ADJUSTING THE TIE-WIRE, WHEN ABNORMALITIES OCCUR, AND WHEN THE EQUIPMENT IS NOT BEING USED

Leaving the equipment switched on in these situations may cause breakdowns or damage.



7. **KEEP FINGERS AND BODY PARTS CLEAR OF THE FEEDER ARM AND CURL GUIDE AT ALL TIMES**

Failure to do so may result in serious injury.



8. **KEEP FINGERS AND BODY PARTS AWAY FROM THE TIE-WIRE REEL WHEN TOOL IS IN OPERATION**

Failure to do so may result in serious injury.



9. **DON'T POINT THE TOOL AT ANYONE**

Personal injury may result if the tool catches an operator or anyone working near him. While working with the tool, be extremely careful not to bring hands, legs, and other body parts near the arm of the tool.



10. **WHEN THE TOOL IS NOT IN OPERATION KEEP YOUR FINGERS OFF THE TRIGGER**

Failure to do so may cause accidental tying, leading to serious injury.



11. **NEVER OPERATE THE TOOL UNDER ANY ABNORMAL CONDITION**

If the tool is not in good working order, or if any abnormal condition is noticed, switch it off immediately (set the Main switch at OFF), lock the Trigger and have it examined and repaired.



12. **AFTER BATTERY INSTALLATION IF THE TOOL OPERATES WITHOUT THE TRIGGER BEING PULLED OR THE OPERATOR NOTICES UNUSUAL HEAT, SMELL, OR SOUND, DISCONTINUE OPERATION**

Failure to do so may lead to serious injury. Return to dealer for safety inspection.



13. **NEVER MODIFY THE TOOL**

Modifying the tool will impair performance and operating safety. Any modification may lead to serious injury and void the tool warranty.



14. **MAINTAIN THE TOOL IN GOOD OPERATING CONDITION**

To secure operating safety and ensure top performance, keep the tool free of wear and damage. Also keep the tool's hand grip dry and clean, especially free of oil and grease.



JP509H

15. USE ONLY THE AUTHORIZED BATTERY PACK

Use only an authorized JP battery pack. If the tool is connected to a power supply other than the authorized pack, such as a rechargeable battery, a dry cell, or a storage battery for use in automobiles, the tool may be damaged, break down, overheat, or even catch on fire. Don't connect this tool to any power supply except the authorized JP battery pack.



16. TO ENSURE MAXIMUM PERFORMANCE, FULLY CHARGE THE BATTERY BEFORE USE

A new battery pack or one not used for extended periods may have self-discharged and thus may need recharging to restore it to a fully charged condition. Before operating the tool, make sure to charge the Battery pack with the designated MAX Battery charger JC524H.



JC524H

17. BATTERY CHARGING PRECAUTION

- ① Use only authorized battery charger MAX Battery charger JC524H and Battery Pack JP509H

Failure to do so may cause the Battery to overheat or catch fire leading to serious injury.

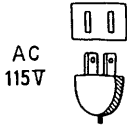

- ② Charge the Battery only to an AC 115V wall socket

Failure to do so may result in overheating, or inadequate charging possibly causing serious injury.



- ③ Never use a transformer



- ④ Never connect the Battery charger to an engine generator direct-current power supply

The charger will break down or be damaged from burning.



- ⑤ Avoid charging the Battery pack in the rain, in a damp place, or where water is splashing

Charging a damp or wet Battery pack will cause an electric shock or a short circuit that may lead to damage from burning and even the tool catching on fire.



- ⑥ Don't touch the power cord or plug with a wet hand or glove

This may cause injury from electric shock.



- ⑦ Don't put a cloth or any other cover on the Battery charger while the Battery pack is being charged

This will cause overheating and damage from burning, or the Charger may even catch fire.



8 Keep the Battery pack and Battery charger away from heat and flames



9 Do not charge the Battery pack near flammable materials



10 Charge the Battery pack in a well ventilated place
Avoid charging the Battery pack where it will be in direct sunlight.

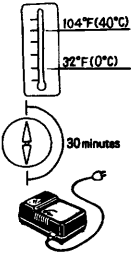

11 Charge the Battery pack in a temperature range of 0°C (32°F) to 40°C (104°F)

12 Avoid continual use of the Battery charger
Rest the Charger for 30 minutes between charges to avoid functional trouble with the unit.



13 Any objects that block the ventilation holes or Battery pack receptacle may cause electric shock or functional troubles
Operate the charger free of dust or other foreign materials.



14 Handle the power cord carefully
Don't carry the Battery charger by its power cord. Don't use the power cord to disconnect it from a wall socket; this will damage the cord and break the wires or cause a short circuit. Don't let the power cord contact sharp edged tools, hot materials, oil, or grease. A damaged cord must be repaired or replaced.



15 Put a pack cap on the terminal of the Battery pack
When the Battery pack is not in use, put a pack cap on its terminal to prevent short circuits.



16 Don't let the terminal (metal component) of the Battery pack short-circuit
A short circuit in the terminal will generate a large current, causing to overheat the Battery pack and become damaged.

18. WEAR SAFETY GROVES WHILE OPERATING THE TOOL

The finish tie has sharp edges. To avoid serious injuries, be careful not to touch the sharp edges. MAX recommends wearing OSHA approval safety groves while operating the tool.

3. SAFETY FEATURES

In order to ensure safety during operation, the RB655 has the following safety features.

▲ WARNING:

- Prior to using the tool, make sure that the safety features function properly. If they do not, avoid using the tool.

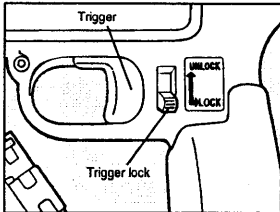

- **Trigger Lock**

The Trigger can be locked preventing the tool from operating for your safety. Always keep the Trigger locked when not in use.

Unless you are at using the tool, set the Trigger lock to the position of LOCK and remove the Battery pack. When you are ready to use the tool, set it to the position of UNLOCK.

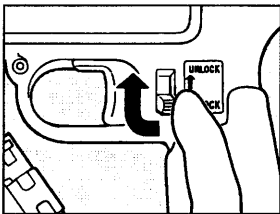

Push the Trigger lock to the left slightly, then upwards to UNLOCK.

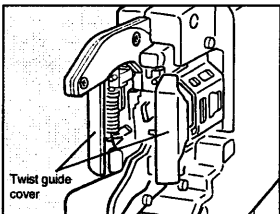

- **Twist Guide Cover**

If the Trigger is pulled with the Twist guide cover opened, the tool will stop and emit a beeping. Release the Trigger and close the Twist guide cover. You can resume tying.

4. BATTERY INSTRUCTIONS

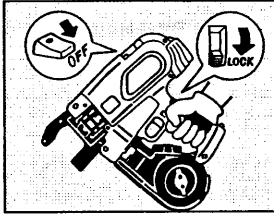

1 Charging

⚠ WARNING:

- Before removing the Battery pack from the tool, set the Main switch at OFF and lock the Trigger.

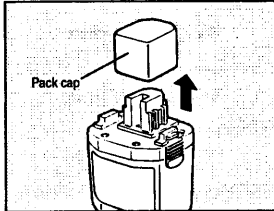

- ① A Pack cap that is used to prevent short circuits must be removed from the terminal of the Battery pack.

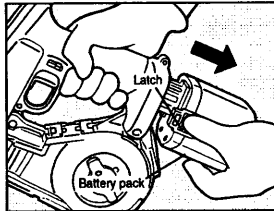

When charging the Battery pack, remove it by pushing on its latches from both sides while firmly holding the grip of the tool.

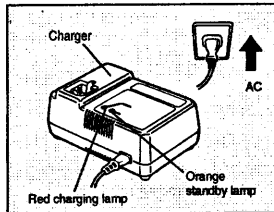

- ② Connect a power cord to the charger. Plug the Charger into a 115V wall socket. The red light, a current-carrying indicator, blinking.

When the orange standby light is lit

When the Battery pack is hot (after continuous use or exposure to direct sunlight) the Charger will automatically switch to standby to protect the Battery. The orange standby light will blink until the Battery's temperature lowers to a safe level. The Battery will then be charged automatically.

When the Battery pack is at low temperature

When the Battery pack is at low temperature, its charging is automatically suspended until its temperature increases, in order to protect it, even if it is set in the Charger. Leave the Battery pack at normal temperature in the room for some time, and then, charge it again.

When the orange standby light blinks

This indicates the Battery cannot be charged. Unplug the Charger and check the charging receptacle. If there are any foreign objects, remove them with a soft dry cloth. If the orange light still blinks or there are no foreign objects, there may be a problem with the battery or charger. Return to dealer for service.

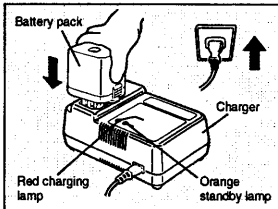

③ Charge the Battery pack.

1. Fully insert the Battery into the receptacle on the Charger until it sits securely on the bottom.
2. Charging will start automatically and will be indicated by the red charging light.
3. Charging time is approximately 30 minutes. This will vary by temperature and source voltage.

When the Battery pack is charged to 80 to 90% of its capacity, the auxiliary charging mode takes effect and allows use of the Battery pack.

Regarding tying times per charge, a brand-new battery ties approximately 400 times per charge. The tying times per charge will be decreased gradually by repeated re-charge until the Battery becomes unusable. The tying times per charge depend on temperature and the Battery condition.

Tips for maximum Battery life

- ① If you repeatedly charge the Battery before fully using it, it will memorize an additional charging capacity as its maximum charge. This phenomenon is called "Memory Effect". If this happens, the Battery's capacity will be decreased, even if it is fully charged. In order to prevent the memory effect, charge the battery only after the tying speed slows down considerably.
- ② Use two Battery packs alternately.
To extend Battery life, alternate between the two batteries provided.

Battery pack breakdowns

If the following conditions occur, bring the Battery and Charger to your dealer.

- The red charging lamp does not flash when the Charger plug is inserted into an AC 115V main power source outlet (When the Battery pack is not inserted in the Charger.)
- Neither the red charging lamp nor the orange standby lamp lights or flashes when the Battery pack is inserted in the charger.
- The orange standby lamp does not change to the red charging lamp even after more than 1 hour.
- The red charging lamp does not change from constant to flashing light even after more than 90 minutes.

Service Life of the Battery Pack

- If the Battery pack has been properly charged (fully charged), but runs out more quickly than usual. The Battery pack is at the end of its service life. Replace it with a new one.

Recycling a Battery

The RB655 Battery Pack (JP509H) is a Ni-MH battery, it may be illegal to dispose of this Battery into the municipal waste system. Check with your local solid waste officials for details in your area for recycling options or proper disposal.

⚠ CAUTION:

When disposing of the Battery pack, make sure to put a pack cap on its terminal (with insulating tape securing it) to prevent short circuits.

5. OPERATING INSTRUCTIONS

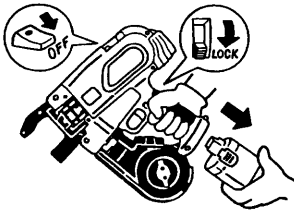

1 How to set the Tie-Wire

⚠ WARNING:

- Be sure to set the Main switch to off, to lock the Trigger, and detach the Battery pack.

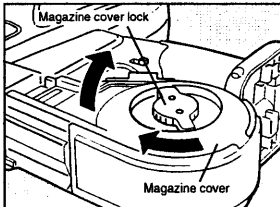

- ① Turn the Magazine cover lock clockwise to open the Magazine cover.

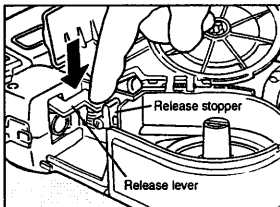

- ② Press the Release lever, and check that it is caught in the Release stopper.

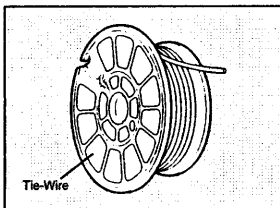

- ③ Unhook and extend the tip of the wound Tie-Wire.

BE SURE TO USE ONLY THE SPECIFIED TIE-WIRE.

The use of Tie-Wire that has not been specified may cause damage to the tool. Therefore, be sure only to use the specified MAX TW1525. Do not use Tie-Wire that is rusted, as it may cause damage to the tool.

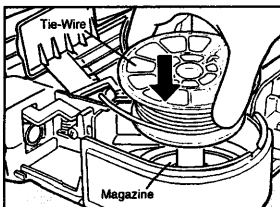

- ④ Directing the tip of the wire toward the Release lever, set the Tie-Wire in the Magazine.

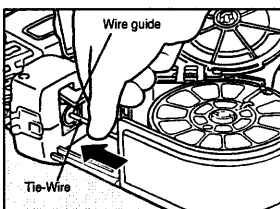

- ⑤ Insert the tip of the Tie-Wire into the Wire guide.

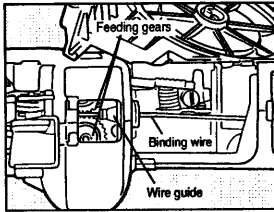

▲ WARNING:

- The tip of the Tie-Wire should be straightened out to allow it to pass through the Wire guide.
When mounting the Tie-Wire, the wire may become jammed inside the machine if the wire tip is bent.

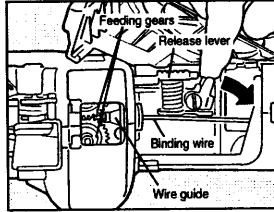

If the Window is dirty and the gear position can not be confirmed

In this situation, open the Window and wipe off the dust on the inside of the Window with a soft cloth, etc. Close the Window after cleaning to ensure that foreign objects will not get into the machine.

- ⑤ Press the Release stopper, and check that the Release lever has returned to its original position and that the Feeding gears are clamping the Tie-Wire mounting.

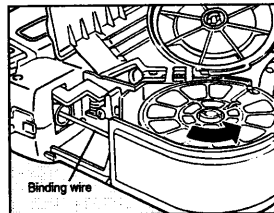

- ⑦ Remove slack from wire reel by turning it counterclockwise.
Make sure the Tie-Wire is not too slack or too taut.
This will avoid getting it caught behind the wire reel and avoid jamming.

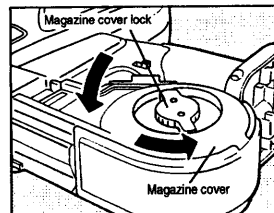

- ⑧ Close the Magazine cover and turn the Magazine cover lock counterclockwise to lock it.

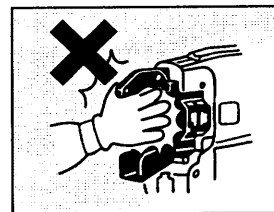

▲ WARNING:

- When turning the Main switch ON, keep hands away from the twisting part of the tool.
- Do not switch the Main switch ON and OFF in rapid succession, since this operation will cause machine breakdowns.
- Do not touch the Tie-Wire during the binding work (while the machine is operating).

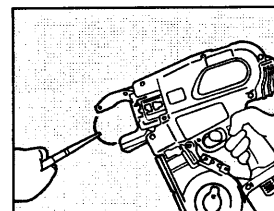

- ⑨ To mount the Battery pack on the tool's main body, insert the charged Battery pack into the main unit until a click is heard. Turn the Main switch on. The tool feeds the wire about 2" (50 mm) and cuts the wire automatically. Remove the cut portion of the wire with pliers.

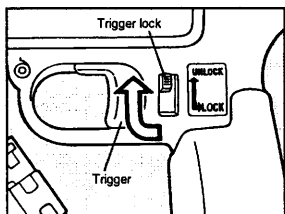

① Unlock the Trigger before using the tool.

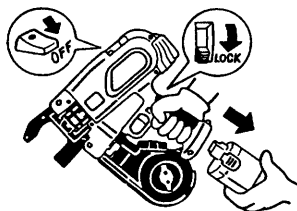

2 How to remove the Tie-Wire

⚠ WARNING:

● Be sure to turn the Main switch OFF, lock the Trigger, and remove the Battery pack.

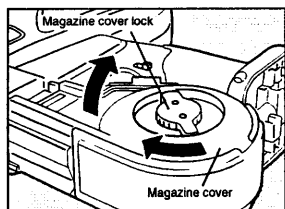

① Turn the Magazine cover lock to open the Magazine cover.

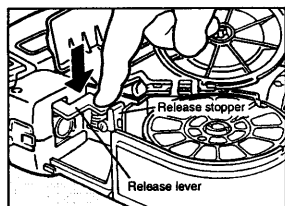

② Press the Release lever, and confirm that the Release lever is caught in the Release stopper.

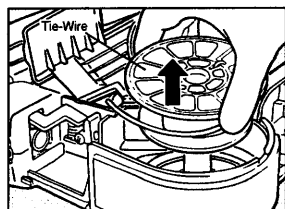

③ Remove the empty Tie-Wire.

When the Tie-Wire runs out

There will probably be a little wire left on the reel. Throw it away when replacing with a new reel.

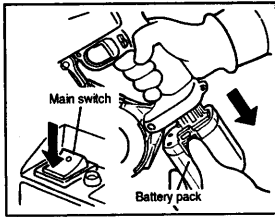

3 Tension adjustment

- ① Be sure to turn the Main switch OFF, to lock the Trigger and detach the Battery pack.

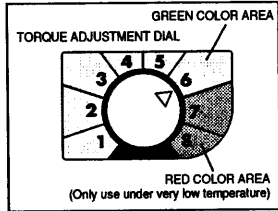

- ② The Torque Adjustment Dial allows you to adjust wire-twisting torque. By setting the dial position at higher numbers, the wire-twisting torque is increased. If the Torque Adjustment Dial is set at a higher position than required, the tie may break when the tie gets stress or vibration. When wire breakage occurs, be sure to turn the Torque Adjustment Dial counterclockwise until the wire breakage stops. The Torque Adjustment Dial position in the red color area (7 to 8) is required only when the tool is used under very low temperature (below 15F/-10°C). Always keep the Torque Adjustment Dial position in the green color area (1 to 6) under normal ambient temperature.

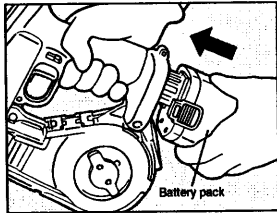

- ③ Insert the charged Battery pack into the main body until a click is heard.

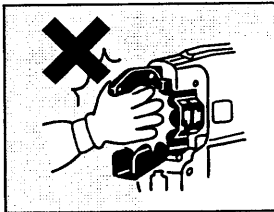

⚠ WARNING:

- When turning the Main switch to ON, keep hands away from the twisting parts of the tool.

- ④ Set the Trigger lock to UNLOCK and turn on the Main switch.
The Tie-Wire is fed automatically to the Arm unit and set in the required position.

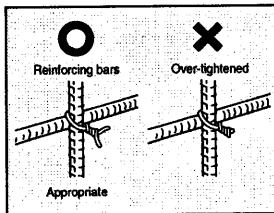

- ⑤ Test the tool again to check the tie strength.

- ⑥ The tie strength is not appropriate, repeat procedures ①~⑤.

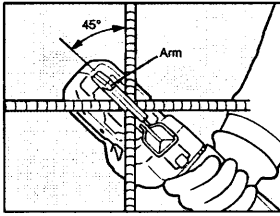

4 For proper tightness

① Tilt the Arm 45° to the intersecting part of the re-bars and push it against them securely.

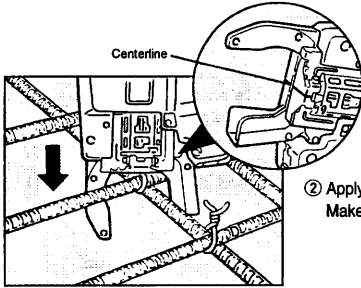

② Apply the tool perpendicularly to the surface of the crossed re-bars. Make the centerline part touch the center of the crossed re-bars.

During tool operation

- Do not move the equipment to the next tying position until the current tying operation has been completed.
- During the tying work (while the machine is operating), there will be a slight pull on the equipment because the hook will twist the binding wire. For this reason, securely grasp the grip during operation.

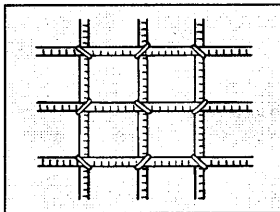

③ Tie in alternate direction.

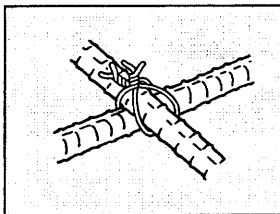

④ Cross tie

If you need the cross tie, bend the tail of the first tie before making the second tie.

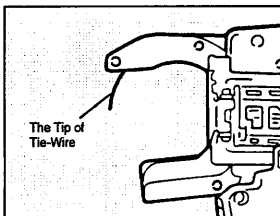

If the tip of the Tie-Wire is deformed, the Hook may not catch the wire and this could result in failure of tying. If this happens, lock the Trigger, turn the Main switch off and then turn it on again. This re-initialization feeds and cuts the wire automatically. Remove the cut end of wire with pliers, unlock the Trigger and try tying again.

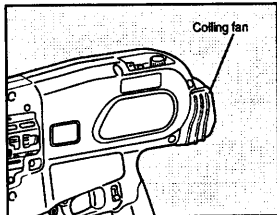

5 Regarding Cooling Fan

The tool is equipped with a cooling fan. When the temperature inside the tool is 0°C (32F) or higher and the trigger is pulled, the fan starts running. The fan stops automatically when one minute passes after the last tying action. If the temperature inside the tool is 0°C (32F) or lower, the fan does not run even when the trigger is pulled.

6 Self-warm-up program

When the RB655 tool is used under cold temperature (below 0°C/30F), you may find the following phenomenon.

- A. The part that catches the tie wire does not fully open after the tying action is completed, and it is hard to pull out the tool from the tied wire.
- B. The tie wire is not cut.

The self-warm-up program is installed to the RB655. Running the self-warm-up program helps to solve the phenomenon above.

How to run the self-warm-up program

Step 1.

Turn the main switch off and remove the tie wire from the tool.

Step 2.

Set Torque dial at position "8" (maximum position).

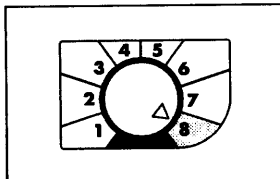

Step.3

Keep pulling the Trigger and turn the Power switch on. The twisting part of the RB655 automatically conducts the twisting action for 60 seconds, then stops.

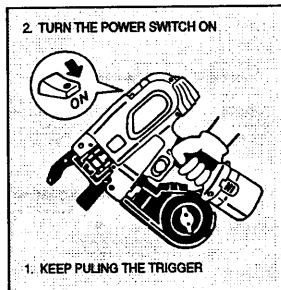

6. TROUBLE SHOOTING / REPAIRS

The troubleshooting and/or repairs shall be carried out only by the MAX CO., LTD. authorized distributors or by other specialists.

This tool alerts you to the following conditions by means of a warning sound and warning lamp. The warning lamp is illuminated or blinks, and is interlocked with the warning sound. Take a countermeasure according to the following table.

No.	Normal Operation	Problem	Warning Sound	What to Check
1.	Power ON ⇒ Wire is automatically fed a little and is cut.	Nothing happens	No sound emitted.	Check the residual capacity of the Battery pack. Take out Battery, and see if electrodes have turned brown.
			Beep	Open and close Twist guide cover.
			Bip, bip, bip	Turn off Main switch and take out Batteries to see if Tie-Wire has been entangled inside Twist guide cover.
2.	Trigger pulled ⇒ Wire is fed.	The wire is not fed.	Beep	Open and close Twist guide cover.
			Bip-bip-bip, Bip-bip-bip	Check if Wire inside reel has been loosened and caught. Check functioning of Cutter section.
			Bip-bip-bip-bip-bip	Warning sound does not go continuously. It occurs only when Trigger is pulled.
			Bip-bip-bip-bip-bip-bip, Bip-bip-bip-bip-bip-bip	Check if the Cooling fan is working.
		Wire feeding is stopped halfway.	Bip-bip-bip-bip, Bip-bip-bip-bip	Check that reel fits snugly into Magazine.
		Bip-bip-bip, Bip-bip-bip	Check that Wire is inserted properly.	
	Tying speed becomes slow. Twister catches the tail of the tie.	Bip-bip, Bip-bip	Check the residual capacity of the Battery pack.	
3.	Wire is returned.	Idling occurs.	No sound heard.	See if any Wire is left around a reel.
4.	Tie-Wire makes a circle.	Circle misshapen or extends beyond.	No sound emitted.	Check if Wire hits re-bars while tool is in use.
5.	Wire is cut.	The wire is not cut.	No sound emitted.	Check functioning of Cutter section.
6.	Wire is twisted.	Wire gets entangled.	No sound emitted.	Check if Wire hits re-bars while tool is in use.
		Tying power is weak.	No sound emitted.	Check size of re-bars to be bound. (⇒ P.5)
				Check how to position tool against re-bars.
		Twisting wire too much and breaks it.	No sound emitted.	Check size of re-bars. (⇒ P.5)
Check how to position tool against re-bars.				
	It is hard to pull out the tool from the tied wire.	No sound emitted.		

- The tool may emit beep sounds (Bip-bip, Bip-bip) when you use it in low temperature (below 0°C/32°F) even though the battery is fully charged. It is not a failure and you can keep using the tool.

▲ WARNING:

- If any of the following conditions occur, be sure to set the Main switch to OFF before carrying out the countermeasures.
- When setting the Main switch to ON, absolutely do not touch the tying part or rotating part of the tip.
If the problem is not solved by carrying out the above countermeasures, be sure to set the Main switch to OFF and then contact the location where the equipment was purchased or MAX CO., LTD. authorized distributors.

Cause	Solution
Dead battery (Completely empty)	Charge the Battery pack.
Electrode plates have been oxidized.	Polish terminal part of Battery pack with dry cloth, etc.
Twist guide cover is left open.	Fully close Twist guide cover.
Tie-Wire has been entangled around Twist section.	Turn off Main switch, remove Tie-Wire inside Twist guide cover.
Twist guide cover is left open.	Fully close Twist guide cover.
Wire caught inside reel.	Tighten Tie-Wire on reel.
Cutter section is blocked with foreign substance.	Either wipe Cutter section with dry cloth or blow it with air.
Motor is overheated.	Turn off Main switch and let it cool down.
Foreign substance prevents the Fan from working.	Clean up the Fan with compressed air.
Wrong type of Wire has been used.	Use MAX Tie-Wire TW1525.
Tie-Wire has been entangled inside reel.	Tighten Tie-Wire on reel.
Dead battery.	Charge the Battery pack.
Wire has run out.	Insert new Tie-Wire.
When Wire hits re-bars, it is repelled.	Pay attention so that Wire does not hit re-bars.
Cutter section is blocked with foreign substance or the tool is used under cold temperature (below 0°C/30F).	Either wipe Cutter section with dry cloth or blow it with air. In cold temperature, try running the self-warm-up program. (⇒ P.19)
When Wire hits re-bars, it is repelled.	Pay attention so that Wire does not hit re-bars at tying.
Re-bars is not the correct size.	Use appropriate diameter scope.
Improper usage of tool.	Turn torque dial as needed position tool perpendicularly against re-bars and fit 45° to the cross. (⇒ P.18)
Twist guide cover is open while tool is in use.	Keep the tool steady while using it.
Re-bars are not the correct size.	Use appropriate diameter scope.
Improper usage of tool.	Turn torque dial as needed position tool perpendicularly against re-bars and fit 45° to the cross. (⇒ P.18)
The part that catches the wire does not fully open after the tying action is completed.	Try running the self-warm-up program. (⇒ P.19)

7. MAINTAINANCE

1 Regularly inspect the equipment

In order to maintain the performance of this equipment, periodically carry out cleaning and inspection of the equipment.

2 Do not lubricate the equipment

Absolutely do not lubricate this equipment. Applying lubrication will remove the enclosed grease, etc. and will cause breakdown of the equipment.

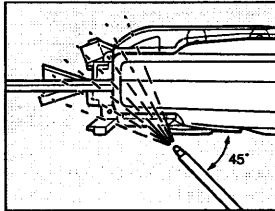
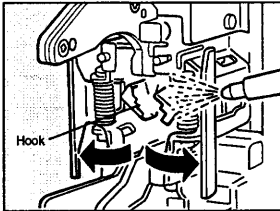

- 3 Holding a Twist guide cover opened, remove metal fragments and dust by compressed air. Blow in the compressed air at the angle of 45° at the back of the tool. Clean up the Hook.

8. STORAGE

Do not store the tool in a cold weather environment. Keep the tool in a warm area.

When not in use, the tool should be stored in a warm and dry place. Keep out of reach of children. All quality tools will eventually require servicing or replacement of parts because of wear from normal use.

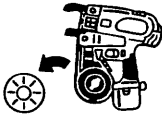

REMOVE REEL OF WIRE

When you have finished binding wires, remove the Tie-Wire from the tool.

STORE THE TOOL

When you have finished binding wires or when the tool will not be used for a while, switch off the tool, make sure the Motor has stopped, lock the Trigger, and remove the Battery pack. With a Pack cap installed on the Pack's terminal to prevent short circuits tool, attachments, and accessories should be stored in a well-ventilated dry place where the temperature will not exceed 50°C (122°F). The storage area must be locked and out of the reach of children.